

# VisiSight Miniature Photoelectric Sensors

Catalog Numbers 42JS-P2MNB1-F4, 42JS-P2MPB1-F4, 42JS-P2MNA2-F4, 42JS-P2MPA2-F4, 42JT-P2LAT1-P4, 42JT-P8LAT1-P4, 42JT-C2LAT1-P4, 42JS-D2MNA2-F4, 42JS-D2MPA2-F4, 42JS-D2MNA1-F4, 42JS-D2MPA1-F4, 42JT-D2LAT1-P4, 42JT-D8LAT1-P4, 42JS-B2MNB1-F4, 42JS-B2MPB1-F4, 42JS-B2MNB2-F4, 42JS-B2MPB2-F4, 42JT-B2LAT1-P4, 42JT-B2LAT2-P4, 42JT-B8LAT1-P4, 42JT-F5LET1-P4, 42JS-E2EZB1-F4, 42JS-R9MNA1-F4, 42JS-R9MPA1-F4, 42JS-E1EZB1-F4, 42JS-R9MNA2-F4, 42JS-R9MPA2-F4, 42JT-E2EZB1-P4, 42JT-R9LAT1-P4, 42JT-E8EZB1-P4, 42JT-R8LAT1-P4

Topic	Page
42JS VisiSight Sensor	1
Features	1
Available Models	1
Specifications	2
Optical Response Time Characteristics	2
Product Selection	3
User Interface — Sensor Indicators	3
Wiring Diagrams	4
Approximate Dimensions	4
Typical Response Curves	4
42JT VisiSight Sensor	6
Features	6
Available Models	6
Specifications	6
Optical Response Time Characteristics	6
Product Selection	7
User Interface	8
Wiring Diagrams	8
42JT Push Button Lock/Unlock	8
42JT Remote Teach	8
Approximate Dimensions	9
Typical Response Curves	10
Accessories	13

## 42JS VisiSight Sensor



### Features

42JS VisiSight™ sensors include the following features:

- Visible red LED for ease of alignment
- Complementary light and dark operate outputs
- Linear sensitivity adjustment knob or no adjustment models
- Optional snap-on adaptor enables 18 mm mount and facilitates easy sensor replacement
- IP67 rated enclosure

### Available Models

- Polarized retroreflective
- Standard diffuse
- Fixed background suppression
- Transmitted beam



**Table 1 - Specifications**

<b>Attribute</b>	<b>42JS</b>
Certifications	cULus Listed and CE Marked for all applicable directives
Shock	30 g with 1 ms pulse duration, meets or exceeds IEC 60947-5-2
Vibration	10...55 Hz, 1 mm (0.04 in.) amplitude, meets or exceeds IEC 60947-5-2
<b>Environmental</b>	
Enclosure type rating	IP67
Operating temperature	-20...+60 °C (-4...+140 °F)
Relative humidity	5...95% (noncondensing)
Ambient light immunity	Incandescent light 5000 lux
<b>User Interface</b>	
Status Indicator	See <a href="#">User Interface — Sensor Indicators on page 3</a>
Sensitivity adjustment	No adjustment or adjustment knob by cat. no.
<b>Electrical</b>	
Operating voltage	10...30V DC
Current consumption	25 mA max
Protection type	Short circuit, reverse polarity, false pulse, overload
<b>Outputs</b>	
Output type	See <a href="#">Table 3 on page 3</a> .
Output function	Complementary light and dark operate
Load current	100 mA max
<b>Mechanical</b>	
Housing material	Plastic — ABS
Lens material	Plastic — PMMA
Connection type	See <a href="#">Table 3 on page 3</a> .

**Table 2 - Optical Response Time Characteristics**

Attribute	[mm (in.)]			
	Polarized Retroreflective	Diffuse	Background Suppression	Transmitted Beam
Field of view	2.8°	5.5° for 250 (9.8) 4° for 800 (31.5)	14° for 55 (2.16) 17° for 130 (5.12)	4°
Spot size <sup>(1)</sup>	175 (6.89) @ 3.5 m (11.5 ft)	40 (1.57) @ 250 (9.8) 60 (2.36) @ 800 (31.5)	7.6 (0.3) @ 55 (2.16) 11.5 (0.45) @ 130 (5.12)	700 (27.56) @ 10 m (32.8 ft)
Light source	Visible red			Visible red and infrared
Response time	1 ms			

(1) For more information on spot size, refer to [Figure 3 on page 4](#).

**Table 3 - Product Selection**

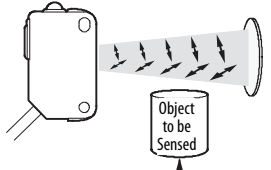
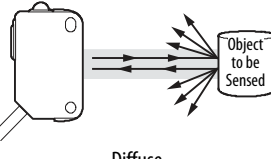
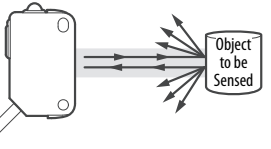
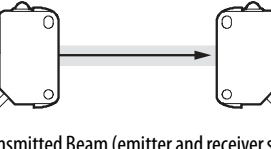
Sensing Mode	Light Source	Sensing Distance	Sensitivity Adjustment	Output Function	Output Type	Cat. No. <sup>(2)</sup>			
 <p>Polarized Retroreflective</p>	Visible red 645 nm	0.025...3.5 m (0.08...11.5 ft) <sup>(1)</sup>	No adjustment	Complementary light and dark operate	NPN	42JS-P2MNB1-F4			
			Adjustment knob		PNP	42JS-P2MPB1-F4			
NPN					42JS-P2MNA2-F4				
PNP			42JS-P2MPA2-F4						
 <p>Diffuse</p>		3...250 mm (0.12...9.84 in.)	Adjustment knob	Complementary light and dark operate	NPN	42JS-D2MNA2-F4			
		PNP			42JS-D2MPA2-F4				
		3...800 mm (0.12...31.5 in.)			NPN	42JS-D2MNA1-F4			
		PNP			42JS-D2MPA1-F4				
 <p>Background Suppression</p>		6...55 mm (0.24...2.17 in.)	No adjustment	Complementary light and dark operate	NPN	42JS-B2MNB1-F4			
		PNP			42JS-B2MPB1-F4				
		2...130 mm (0.07...5.12 in.)			NPN	42JS-B2MNB2-F4			
		PNP			42JS-B2MPB2-F4				
 <p>Transmitted Beam (emitter and receiver sold separately)</p>	Visible red and Infrared 645 nm	10 m (32.8 ft.)	No adjustment	— (Emitter)	—	42JS-E2EZB1-F4			
			Adjustment knob	Complementary light and dark operate	NPN	42JS-R9MNA1-F4			
					PNP	42JS-R9MPA1-F4			
			No adjustment	— (Emitter)	—	42JS-E1EZB1-F4			
			Adjustment knob	Complementary light and dark operate	NPN	42JS-R9MNA2-F4			
					PNP	42JS-R9MPA2-F4			
			Recommended DC micro (M12) quick-disconnect cordset, straight, 4-pin, 2 m						889D-F4AC-2
			Recommended DC pico (M8) quick-disconnect cordset, straight, 4-pin, 2 m						889D-F4AB-2

(1) Sensing distance with 92-124 reflector.

(2) The -F4 suffix describes a 4-pin DC micro (M12) QD connector on a 150 mm (6 in.) pigtail. For additional connection options, replace the -F4 suffix with -A2 for a 2 m cable without QD connection (for example, 42JS-P2MPB1-A2), or -Y4 for a 4-pin DC pico (M8) QD connection on a 150 mm (6 in.) pigtail (for example, 42JS-P2MPB1-Y4).

**Table 4 - User Interface — Sensor Indicators**

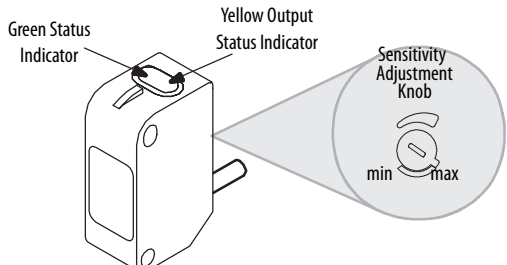
	Status Indicator Color	State	Status
	Yellow	Yellow	Off
On			Output is activated <sup>(1)</sup>
Green	Green	Off	Power is off
		On	Power is on
		Flashing (6 Hz)	Unstable (0.5 < Margin < 2)
		Flashing (1.5 Hz)	Output short-circuit protection active

(1) Black wire or pin 4 of connector.

**Figure 1 - Wiring Diagrams**

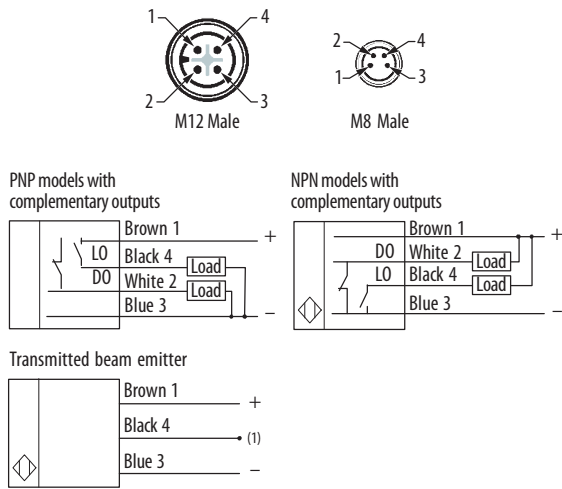

(1) For normal operation, black wire (pin 4) needs no connection. To disable the light source, connect the black wire (pin 4) to +V.

**Figure 2 - Approximate Dimensions**

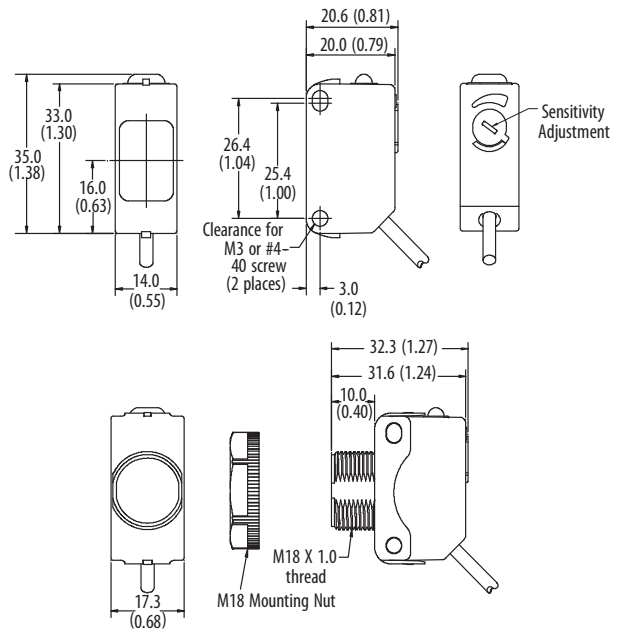

**Figure 3 - Typical Response Curves**

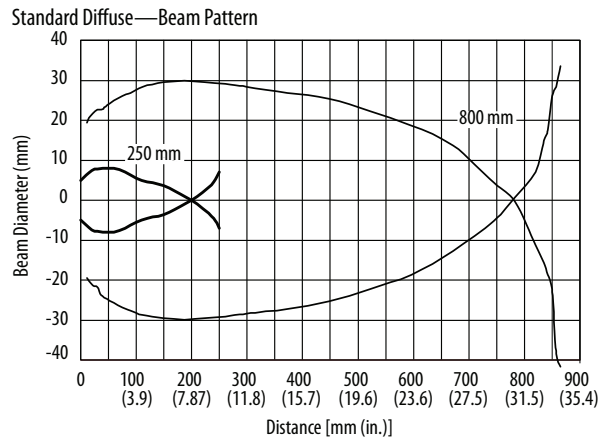
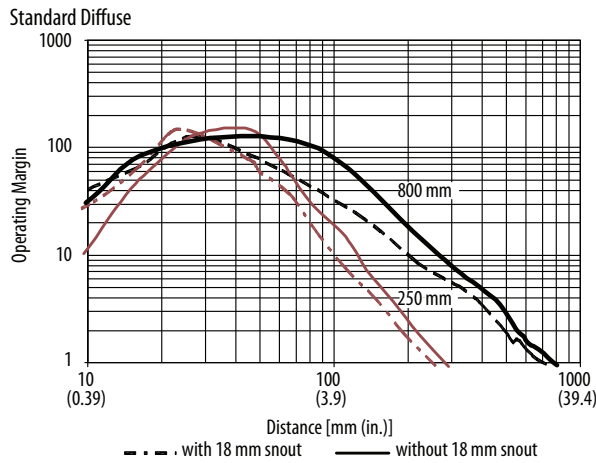

Background Suppression (55 mm)

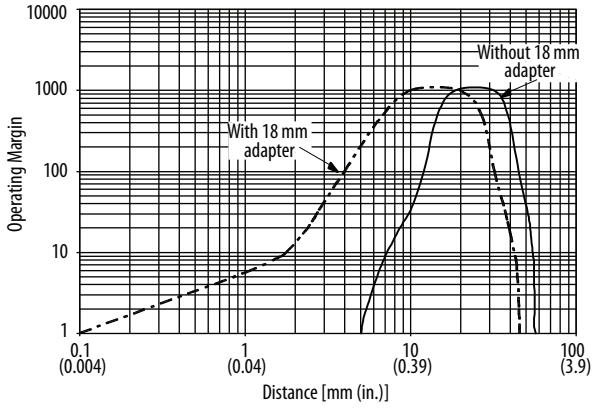

Background Suppression (55 mm)—Beam Pattern

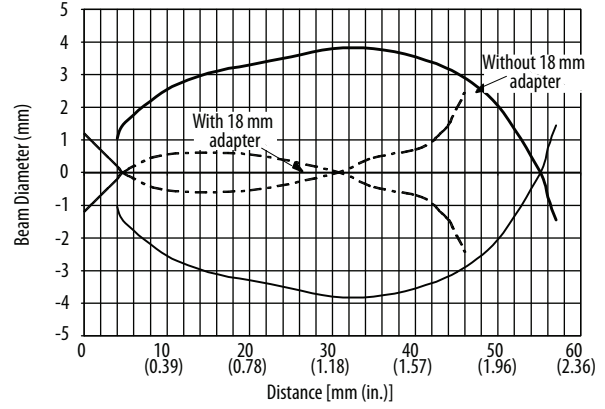

Background Suppression (130 mm)

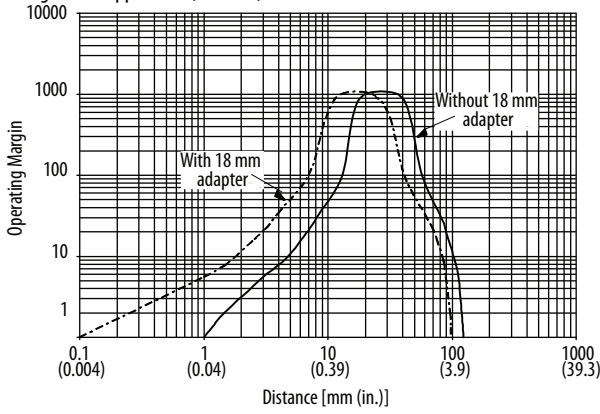

Background Suppression (130 mm)—Beam Pattern

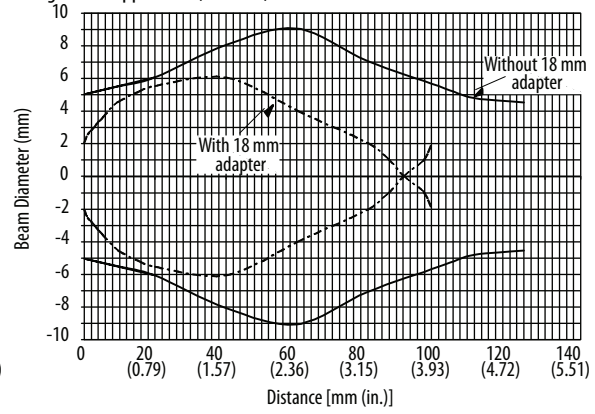

Polarized Retroreflective

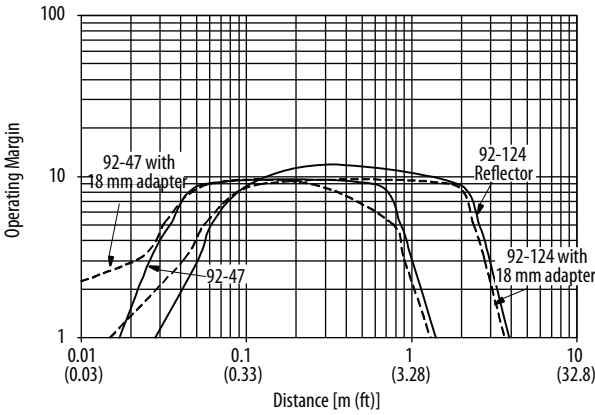

Polarized Retroreflective—Beam Pattern

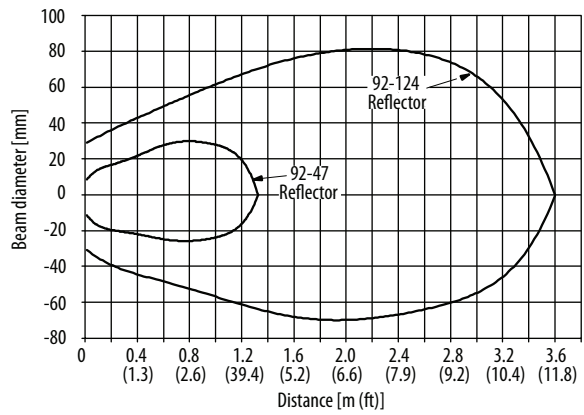

Transmitted Beam—Visible Red and Infrared

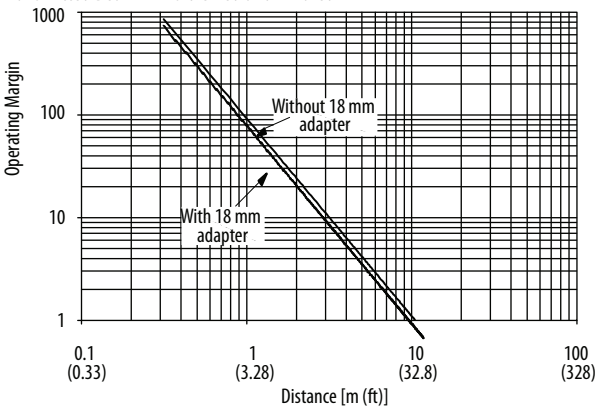

Transmitted Beam—Beam Pattern

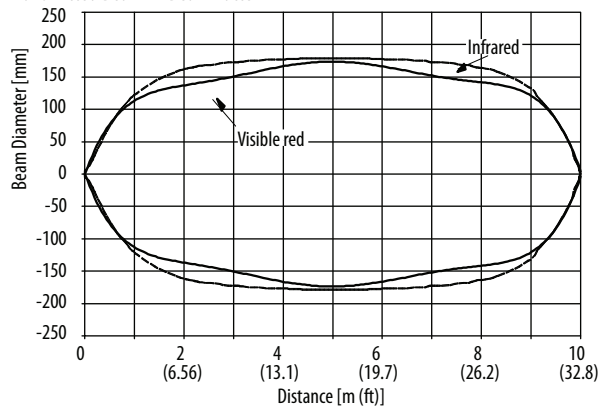

## 42JT VisiSight Sensor



### Features

42JT VisiSight Sensors include the following features:

- Class 1 eye-safe red laser beam (for small object and contrast detection) and visible LED models
- Unique auto PNP/NPN output reduces stocking cost and simplifies selection, installation, and maintenance
- Teach push button for sensitivity and L.O./D.O. selection
- IP69K enclosure rating and ECOLAB tested to withstand food industry cleaning chemicals
- Laser etched markings for durability

### Available Models

- Polarized retroreflective
- Standard diffuse
- Adjustable background suppression
- Transmitted beam
- Clear object
- Color mark

**Table 5 - Specifications**

Certifications	c-UL-us Listed and CE Marked for all applicable directives
Shock	30 g with 1 ms pulse duration, meets or exceeds IEC 60947-5-2
Vibration	10...55 Hz, 1 mm amplitude, meets or exceeds IEC 60947-5-2
<b>Environmental</b>	
Enclosure type rating	IP67 and IP69K
Operating temperature	-20...+60 °C (-4...+140 °F)
Relative humidity	5...95% (noncondensing)
Ambient light immunity	Incandescent light 5000 lux
<b>User Interface</b>	
Indicator LEDs	See <a href="#">Table 8 on page 8</a>
Sensitivity adjustment	Teach button
<b>Electrical</b>	
Operating voltage	10...30V DC
Current consumption	30 mA max
Protection type	Short circuit, reverse polarity, false pulse, overload
<b>Outputs</b>	
Output type	See <a href="#">Table 7 on page 7</a> .
Output function	Teachable light or dark operate
Load current	100 mA max
<b>Mechanical</b>	
Housing material	Plastic — ABS
Lens material	Plastic — PMMA
Connection type	See <a href="#">Table 7 on page 7</a> .

**Table 6 - Optical Response Time Characteristics**

Attribute	[mm (in.)]					
	Polarized Retroreflective	Clear Object Detection	Diffuse	Background Suppression	Color Mark	Transmitted Beam
<b>Visible Red 660 nm (except for Color Mark Models)</b>						
Spot size <sup>(1)</sup>	500 (19.7) @ 6 m (236.22 ft)	40 (1.57) @ 1 m (3.28)	70 (2.75) @ 800 (31.5)	15 (0.59) @ 180 (7.09) 27 (1.06) @ 400 (15.75)	1 x 4 (0.16) @ 12 (0.47) (white LED)	1.1 m (3.61 ft) @ 13 m (42.65 ft)
Response time	0.5 ms	0.5 ms	0.5 ms	0.5 ms	50 µs	0.5 ms
<b>Class 1 Laser 650 nm</b>						
Spot size <sup>(1)</sup>	14 (0.55) @ 13 m (42.65 ft)	—	0.6 (0.02) @ 250 (9.84)	1.3 (0.05) @ 120 (4.72)	—	13 (0.51) @ 18 m (59.05)
Response time	0.25 ms	—	0.333 ms	0.5 ms	—	0.25 ms

(1) For more information on spot size, refer to [Figure 6 on page 10](#).

**Table 7 - Product Selection**

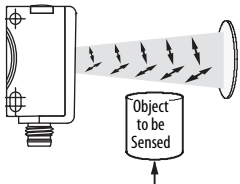
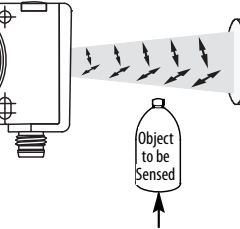
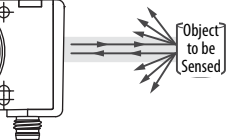
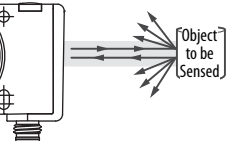
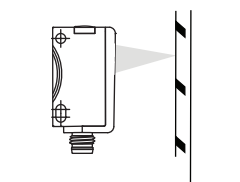
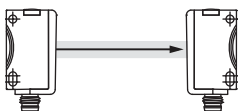
Sensing Mode	Light Source	Sensing Distance	Sensitivity Adjustment	Output Function	Output Type	Cat. No. <sup>(3)</sup>
Polarized Retroreflective 	Visible red 660 nm	0.1...6 m (0.33...19.7 ft) <sup>(1)</sup>	Teach button	Teachable light or dark operate	Auto PNP or NPN	42JT-P2LAT1-P4
	Class 1 laser	0.05...13 m (0.16...42.7 ft) <sup>(2)</sup>				42JT-P8LAT1-P4
Clear Object Detection 	Visible red 660 nm	2 m (6.6 ft) <sup>(2)</sup>	Teach button	Teachable light or dark operate	Auto PNP or NPN	42JT-C2LAT1-P4
Diffuse 	Visible red 660 nm	3...800 mm (0.12...31.5 in.)	Teach button	Teachable light or dark operate	Auto PNP or NPN	42JT-D2LAT1-P4
	Class 1 laser	5...250 mm (0.20...9.84 in.)				42JT-D8LAT1-P4
Background Suppression 	Visible red 660 nm	1...180 mm (0.4...7.1 in.)	Teach button	Teachable light or dark operate	Auto PNP or NPN	42JT-B2LAT1-P4
		3...400 mm 0.12...15.75 ft				42JT-B2LAT2-P4
	Class 1 laser	4...120 mm (0.16...4.72 in.)				42JT-B8LAT1-P4
Color Mark 	White LED 400...780 nm	12 ± 2.5 mm (0.47 ± 0.98 in.)	Teach button	Teachable light or dark operate	PNP or NPN (push pull)	42JT-F5LET1-P4
Transmitted Beam (emitter and receiver sold separately) 	Visible red 660 nm	13 m (42.65 ft)	No adjustment	— (Emitter)	—	42JT-E2EZB1-P4
			Teach button	Teachable light or dark operate	Auto PNP or NPN	42JT-R9LAT1-P4
	Class 1 laser	18 m (59.05 ft)	No adjustment	— (Emitter)	—	42JT-E8EZB1-P4
			Teach button	Teachable light or dark operate	Auto PNP or NPN	42JT-R8LAT1-P4
Recommended DC micro (M12) quick-disconnect cordset, straight, 4-pin, 2 m						889D-F4AC-2
Recommended DC pico (M8) quick-disconnect cordset, straight, 4-pin, 2 m						889D-F4AB-2

(1) Sensing distance with 92-125 reflector.

(2) Sensing distance with 92-118 reflector.

(3) The -P4 suffix describes a 4-pin DC pico (M8) integral QD connector. For additional connection options, replace the -P4 suffix with -A2 for a 2 m cable without QD connection (for example, 42JT-P2LAT1-A2) or -F4 for a 4-pin DC micro (M12) QD connection on a 150 mm (6 in.) pigtail (for example, 42JT-P2LAT1-F4).

**Table 8 - User Interface**

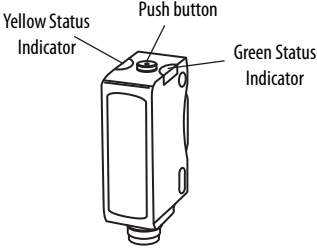
Sensor	Status Indicator Color	State	Status
	Yellow <sup>(1)</sup>	Off	Output is deactivated
		On	Output is activated
	Green	Off	Power is off
		On	Power is on
		Flashing (6 Hz)	Unstable ( $0.5 < \text{Margin} < 2$ )
	Flashing (1.5 Hz)	Output short-circuit protection active	

(1) Except for color mark sensors—color mark sensors have PNP or NPN (push-pull) output. This table shows status indication when output is connected as PNP. If connected as NPN, the yellow status indicator is ON when the output is deactivated and OFF when it is activated.

**Figure 4 - Wiring Diagrams**

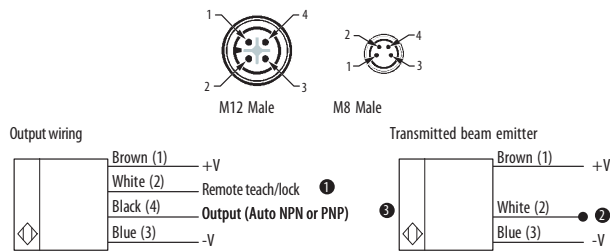

- ❶ Normal operation: no connection.  
Remote teach: See 42JT Remote Teach section.  
Push button lock: connect to a -V. See the 42JT Push Button Lock/Unlock section.
- ❷ For Normal operation, white wire (pin 2) needs no connection. To disable light source, connect white wire (pin 2) to +V.
- ❸ Output is PNP or NPN (push-pull) for color mark sensors.

### 42JT Push Button Lock/Unlock

The push button or remote teach can be used to help prevent unauthorized users from changing teach settings.

To lock the push button press and release the button three times within three seconds. Both status indicators flash synchronously for three seconds, which indicates that the push button is now locked.

To unlock the push button press and release the button three times within three seconds. Both status indicators flash asynchronously for three seconds, which indicates that the push button is now unlocked.

To permanently lock the push button, connect the white wire (pin 2) to -V.

### 42JT Remote Teach

The sensor can be taught remotely via the white wire (pin 2). Connection to +V acts the same as the button being pressed and no connection is the same as the button not being pressed. The sensor can be taught by following the same teach/timing sequence as used in the push button teach (for example, connect to the +V for more than three seconds to teach the target, disconnect from the +V; remove the target and connect to the +V for less than one second to teach the no target condition. All push button functions can also be conducted via remote teach.



**Figure 5 - Approximate Dimensions**

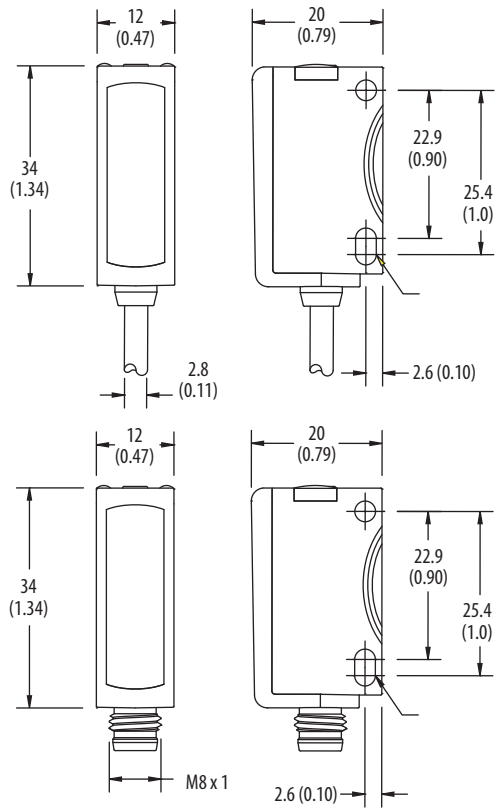

The 42JT mounting holes are located toward the rear end of the sensor while the 42JS mounting holes are located toward the front. Both sensors are compatible with the industry standard 25.4 mm mounting. The 42JT flexible mounting hole space range of 22.9...25.4 mm (0.9...1 in.) makes it compatible with the 24.1 mm (0.95 in.) hole space sensors.

See [www.ab.com/e-tools](http://www.ab.com/e-tools) for two-dimensional and three-dimensional CAD drawings.

**Figure 6 - Typical Response Curves**

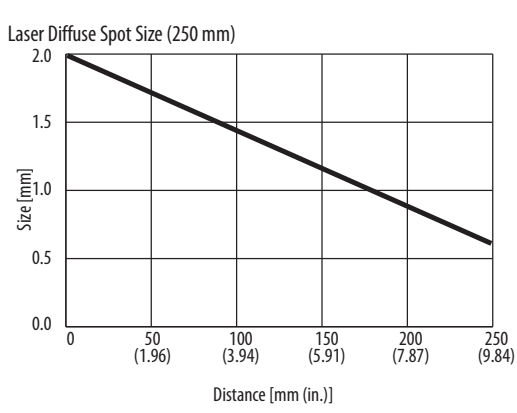
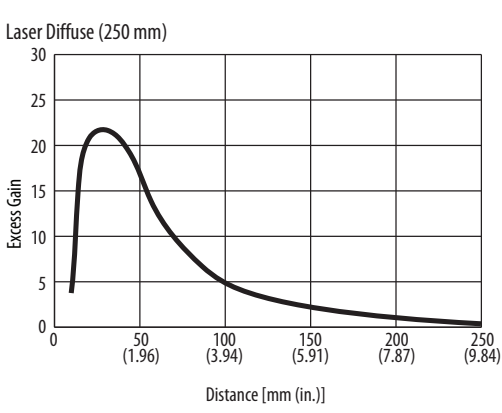
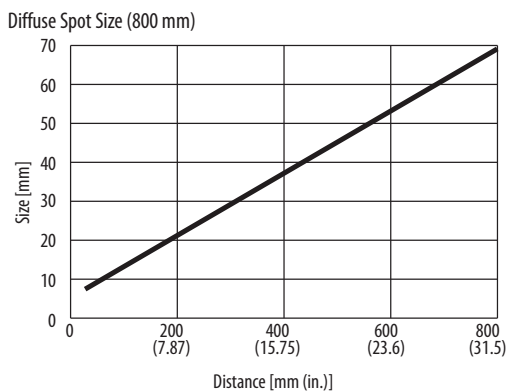
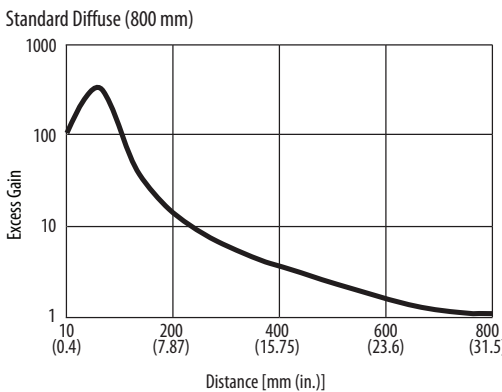
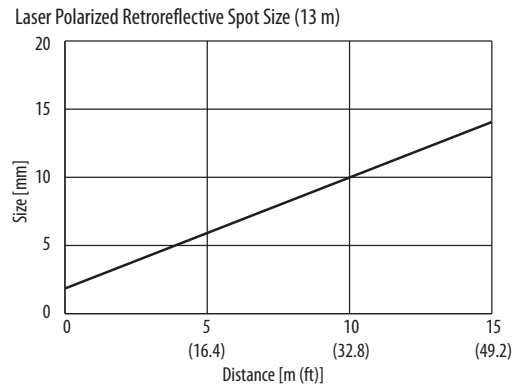
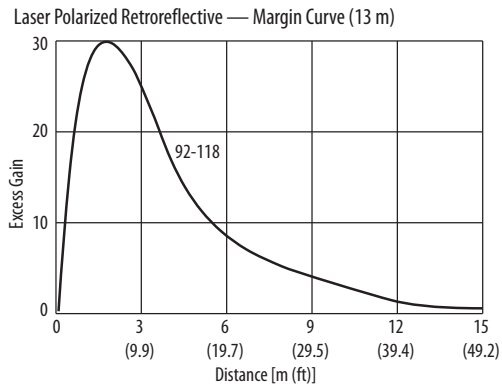
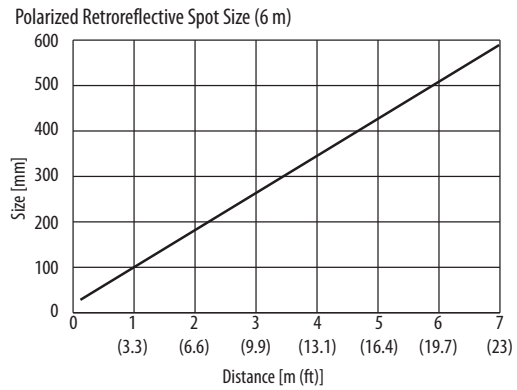
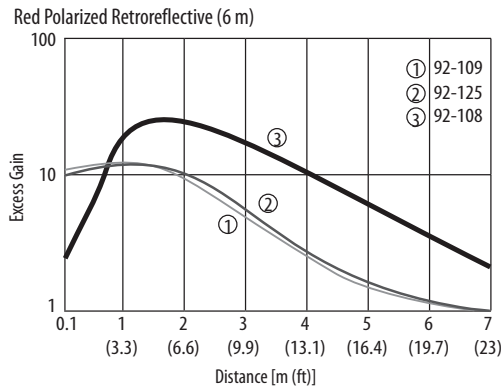

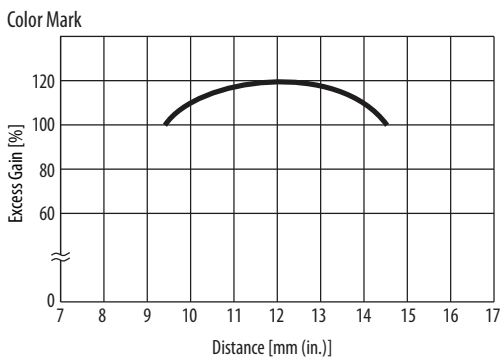
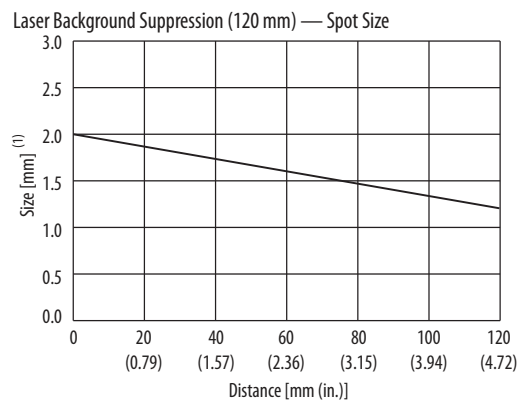
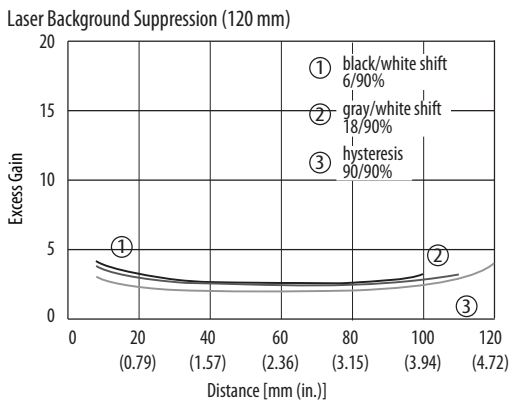
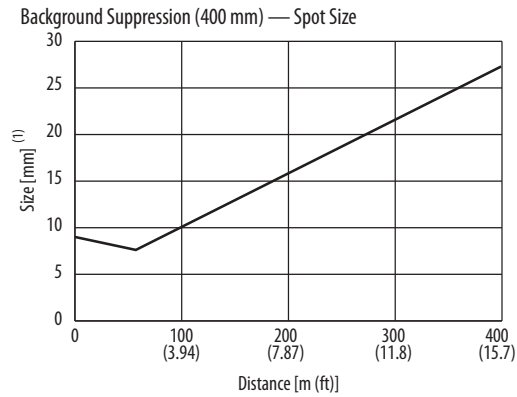
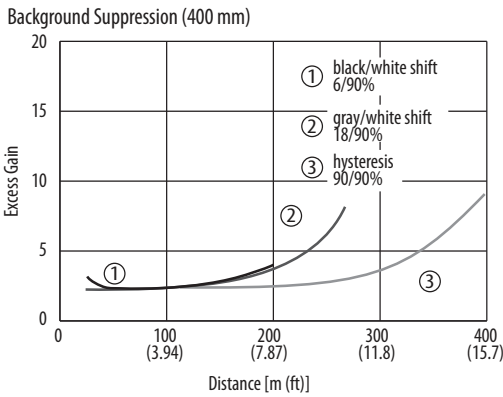
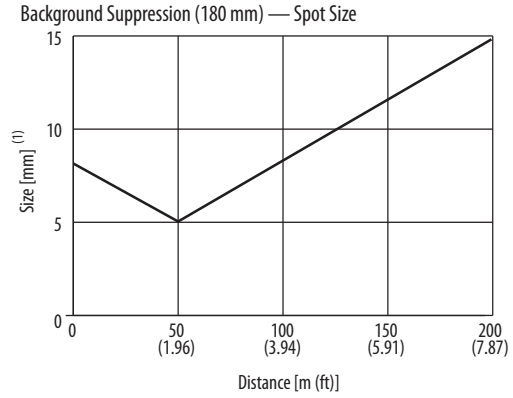
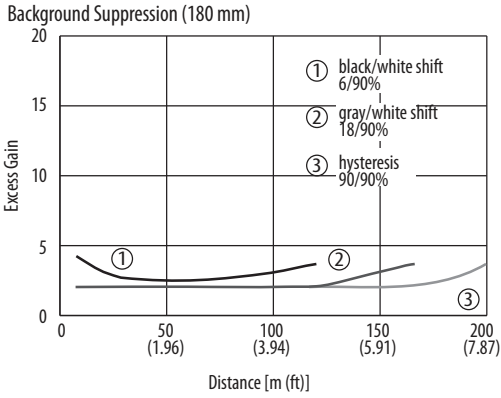

(1) The spot is square in shape with one side dimension per graph.

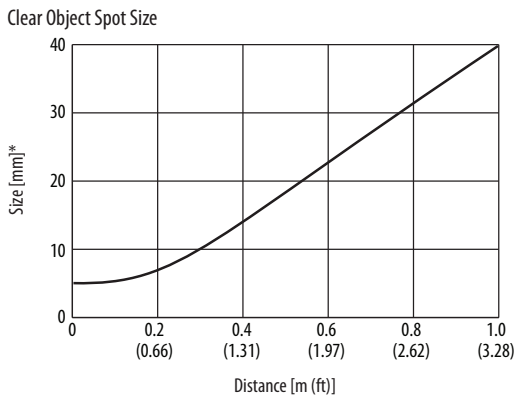
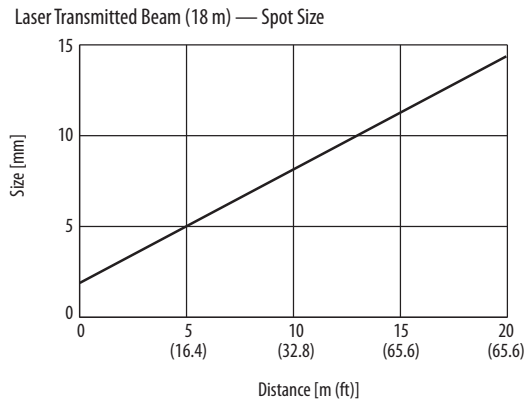
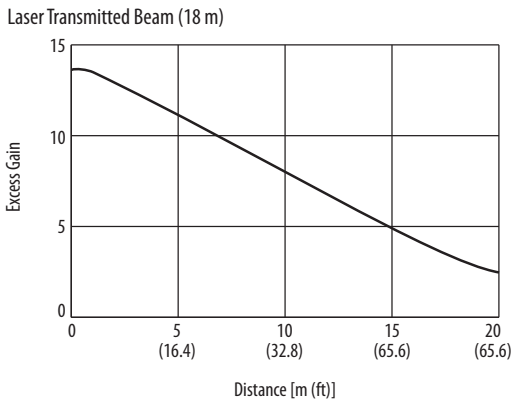
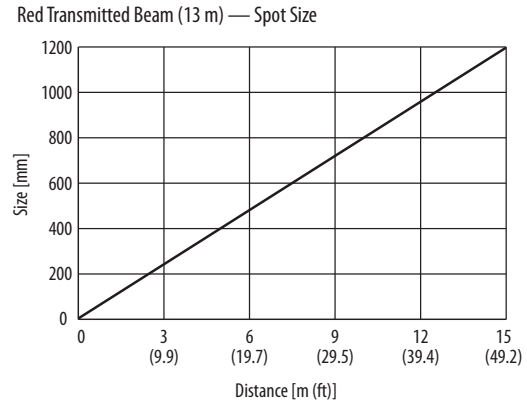
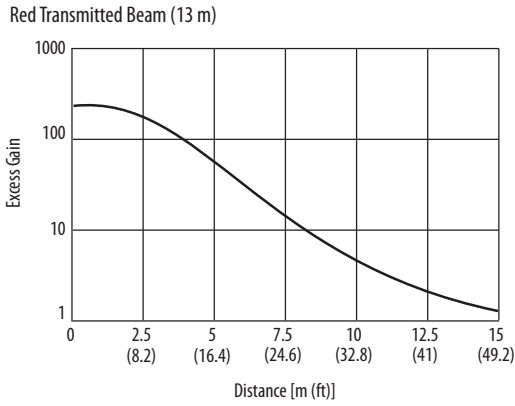

**Table 9 - Accessories**

Description	Cat. No.
DC Micro (M12) QD Cordset, Straight, 4-pin, 2 m	889D-F4AC-2
DC Pico (M8) QD Cordset, Straight, 4-pin, 2 m	889P-F4AB-2
DC Pico (M8) QD Cordset, Right Angle, 4-pin, 2 m	889P-R4AB-2
Mounting Bracket, Stainless Steel, L-Shaped for 42JT and 42JS	60-BJS-L1
Mounting Bracket, Stainless Steel, L-Shaped for 42JS VisiSight	60-BJS-L2
Mounting Bracket, Stainless Steel	60-BKTL-SS
Mounting Bracket, Stainless Steel, L-Shaped for 42JT and 42JS VisiSight	60-BJT-L2
Mounting Bracket, Plastic, swivel/tilt for 42JS VisiSight	60-2619
Replacement Mounting Bracket, Stainless Steel, for replacing larger (50 x 50 mm) sensors	60-BJT-RCS
Protective Mounting Bracket, Stainless Steel, U-shaped for 42JT and 42JS	60-BJT-U1
Protective Mounting Bracket, Stainless Steel, Horizontal, and Vertical for 42JT and 42JS VisiSight	60-BJT-H1
Reflector, Corner Cube, 76 mm (3 in.) diameter	92-124
Reflector, Corner Cube, 84 mm (3.3 in.) diameter	92-125
Reflector, Corner Cube, 32 mm (1.5 in.) diameter	92-47
Reflector, Corner Cube, 100 x 100 mm (4 x 4 in.)	92-108
Reflector, Corner Cube, 51 x 61 mm (2 x 2.5 in.)	92-109
Reflector, Micro Cube, 51 x 61 mm (2 x 2.5 in.) for laser and clear object models	92-118

## Rockwell Automation Support

Use the following resources to access support information.

<b>Technical Support Center</b>	Knowledgebase Articles, How-to Videos, FAQs, Chat, User Forums, and Product Notification Updates.	<a href="http://www.rockwellautomation.com/knowledgebase">www.rockwellautomation.com/knowledgebase</a>
<b>Local Technical Support Phone Numbers</b>	Locate the phone number for your country.	<a href="http://www.rockwellautomation.com/global/support/get-support-now.page">www.rockwellautomation.com/global/support/get-support-now.page</a>
<b>Direct Dial Codes</b>	Find the Direct Dial Code for your product. Use the code to route your call directly to a technical support engineer.	<a href="http://www.rockwellautomation.com/global/support/direct-dial.page">www.rockwellautomation.com/global/support/direct-dial.page</a>
<b>Literature Library</b>	Installation Instructions, Manuals, Brochures, and Technical Data.	<a href="http://www.rockwellautomation.com/literature">www.rockwellautomation.com/literature</a>
<b>Product Compatibility and Download Center (PCDC)</b>	Get help determining how products interact, check features and capabilities, and find associated firmware.	<a href="http://www.rockwellautomation.com/global/support/pcdc.page">www.rockwellautomation.com/global/support/pcdc.page</a>

## Documentation Feedback

Your comments will help us serve your documentation needs better. If you have any suggestions on how to improve this document, complete the How Are We Doing? form at [http://literature.rockwellautomation.com/idc/groups/literature/documents/du/ra-du002\\_-en-e.pdf](http://literature.rockwellautomation.com/idc/groups/literature/documents/du/ra-du002_-en-e.pdf).

Rockwell Automation maintains current product environmental information on its website at <http://www.rockwellautomation.com/rockwellautomation/about-us/sustainability-ethics/product-environmental-compliance.page>.

Allen-Bradley, LISTEN. THINK. SOLVE, Rockwell Automation, Rockwell Software, and VisiSight are trademarks of Rockwell Automation, Inc. Trademarks not belonging to Rockwell Automation are property of their respective companies.

Rockwell Otomasyon Ticaret A.Ş., Kar Plaza İş Merkezi E Blok Kat:6 34752 İçerenköy, İstanbul, Tel: +90 (216) 5698400

**[www.rockwellautomation.com](http://www.rockwellautomation.com)**

### Power, Control and Information Solutions Headquarters

Americas: Rockwell Automation, 1201 South Second Street, Milwaukee, WI 53204-2496 USA, Tel: (1) 414.382.2000, Fax: (1) 414.382.4444  
Europe/Middle East/Africa: Rockwell Automation NV, Pegasus Park, De Kleetlaan 12a, 1831 Diegem, Belgium, Tel: (32) 2 663 0600, Fax: (32) 2 663 0640  
Asia Pacific: Rockwell Automation, Level 14, Core F, Cyberport 3, 100 Cyberport Road, Hong Kong, Tel: (852) 2887 4788, Fax: (852) 2508 1846